

EMH metering

GmbH & Co. KG

Neu-Galliner Weg 1 • 19258 Gallin
GERMANY

Tel.: +49 38851 326-0

Fax: +49 38851 326-1129

Email: info@emh-metering.com

Internet: www.emh-metering.com

Tel.: +49 38851 326-1930 (Technical Support)

Email: support@emh-metering.com

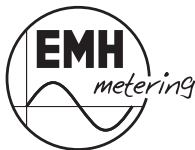

LZQJ-SGM

Digital 4-quadrant/combi meter

EN Instruction manual

Scope of delivery and storage/transport.....	2
Important information.....	2
Technical data	6
Housing, display and control elements.....	8
Installation and start-up	14
Functions and operation.....	26
Installation control register C.86.0	37
Error register F.F.....	39
Combi-Master 2.0 configuration and read-out program.....	40
Communication module.....	40
Abbreviations.....	41
EU Declaration of Conformity	42

Scope of delivery and storage/transport

Please check that the contents of the packing box are complete before starting the installation and start-up procedure.

- 1 LZQJ-SGM device
- 1 operating instructions
- Connection diagram
- Accessory (optional)

If the contents are incomplete or damaged, please contact your supplier.

Store, use and transport the device in such a way that it is protected against moisture, dirt and damage.



Important information

These operating instructions are part of the documentation.

These instructions list all the different device versions. Some of the features described herein may not be applicable to your particular device.

Please see the user manual for more comprehensive information about the device. Please also observe all the documents included with other components (such as the optical communication unit, for example).

Symbols used

 DANGER	Indicates immediate danger that can lead to severe injuries or death unless avoided.
ATTENTION	Indicates a situation that can cause damage to property or the environment unless avoided.
	This note indicates important information in the operating instructions.

Target audience

These instructions are intended for technicians who are responsible for the installation, connection and servicing of the devices.

The device must be installed and put into operation only by qualified electricians in accordance with generally accepted rules of technology and the regulations, which are relevant for the installation of telecommunications equipment and end devices.



After installation and start-up of the meter, make sure that the operating instructions are available to the electricity customer.

Intended use

The meter is intended to be used solely for the measurement of electrical energy in inside spaces, and it must not be operated outside the specified technical data (see name plate).

Make sure that the meter is suitable for the intended application.

Maintenance and warranty instructions

The device requires zero maintenance. It is not permitted to make any repairs independently in the event of any damage (e.g. due to transport or storage).

If the device is opened, the warranty and the Declaration of Conformity will be rendered null and void. The same applies where a defect is caused by external factors (e.g. lightning, water, fire, extreme temperatures and weather conditions), or by improper or careless use or handling.

The seals may only be broken by authorised personnel.

Care and disposal instructions



Risk of fatal injury in case of contact with live parts!

Before the housing of the meter is cleaned, all conductors that the meter is connected to must be de-energised.

Use a dry cloth to clean the device housing. Do not use any chemical cleaning agents!



The symbol showing a crossed-out waste bin on electrical and electronic devices indicates that the device in question must be disposed of separately from unsorted domestic waste after decommissioning.

If a replaceable battery has been provided, it must not be disposed of with normal household waste.

Further disposal instructions can be found on the EMH metering website: www.emh-metering.com

Basic safety instructions

Please adhere to the following basic safety instructions:

- Read all the enclosed instructions and information.
- Observe the warnings on the device and in the documents.
- Always be aware of safety issues and hazards when working on the device.
- The applicable occupational health and safety regulations for electrical installations must be observed during assembly, installation and removal of the device.
- Make sure that the installation and operating location of the device meets the specifications in the technical data.
- Before assembly, check the device for any externally visible damage.
- Only use the device if it is in a technically flawless state, and solely in line with its intended use.

- The connection cables used to connect a meter must be selected to match the maximum load of the meter and the installation environment in terms of type, cross section, voltage and temperature.
- Fit suitable cable end sleeves on multi-stranded, fine-stranded or ultra-fine-stranded connecting lines.
- Observe the maintenance and warranty instructions.
- If the mains power fails and then returns, there is no need to do anything to the meter.

Notes on correctness of measurements



For the notes on correctness of measurements applicable to this meter in Germany, please see the document provided, entitled "Länderspezifische Hinweise zum Messbetrieb für den LZQJ-SGM."

Technical data

Voltage, current, frequency, utilisation category	See name plate	
Overvoltage category	OVC III (as per IEC 62052-31)	
Rated peak withstand voltage	4kV (as per IEC 62052-31)	
Input		
System voltage	min. 100 V...max. 277 V AC	
Low voltage	min. 18 V...max. 40 V DC	
S0 input	max. 27 V DC, 27 mA	
Data interfaces		
Optical	Optical data interface D0 (38400 baud), as per IEC 62056-21	
Electrical	RS232 (115200 baud), as per ANSI EIA/TIA-232-F (R1997)	
	RS485 (115200 baud), as per ANSI/TIA/EIA-485-A-98 (R2003)	
	CL0 (19200 baud), as per DIN 66348-1	
	Ethernet (10/100 Mbps), as per IEEE 802.3	
Customer interface	P1 HAN port (115200 baud), as per DSMR v. 5.0.2	
	Cable length depends on cable type, typ. 2.5 m	
Output		
Opto-MOSFET	max. 250 V AC/DC, max. 100 mA	
Relay	max. 250 V AC, 30 V DC, max. 2 A active load	
Power consumption per phase	Transformer connected meter	Direct connected meter
Voltage circuit		
Meter in multifunction mode with EMH modules (3-wire, 4-wire)	max. 3.8 W / 4.9 VA @ 3 x 58/100 V AC max. 4.0 W / 6.7 VA @ 3 x 240/415 V AC max. 3.2 W / 5.6 VA @ 3 x 277/480 V AC	max. 2.0 W / 3.4 VA @ 3 x 220/380 V AC max. 2.0 W / 3.5 VA @ 3 x 240/415 V AC
Current path	< 0.01 VA @ $I_N = 1$ A < 0.30 VA @ $I_N = 5$ A	< 0.004 VA
Temperature range	Defined operating range: -25 °C...+55 °C Limit range for operation, storage and transport: -40 °C...+70 °C	

Altitude	up to 3,000 m
Humidity	max. 95%, non-condensing, as per IEC 62052-11 and IEC 60068-2-30
Protection class	II
Degree of protection	IP 54 *)
Fire properties	as per IEC 62052-31
Environmental conditions	<p>Mechanical: M1 according to the Measuring Instruments Directive (2014/32/EU)</p> <p>Electromagnetic: E2 according to the Measuring Instruments Directive (2014/32/EU)</p> <p>Intended operating location: Interior as per IEC 62052-11 Version 3 x 277/480 V for industrial use only (not for use in residential areas)</p>
Weight	Max. 1.2 kg

*) IP51 is achieved for the version with terminal cover for customer interface

Housing, display and control elements

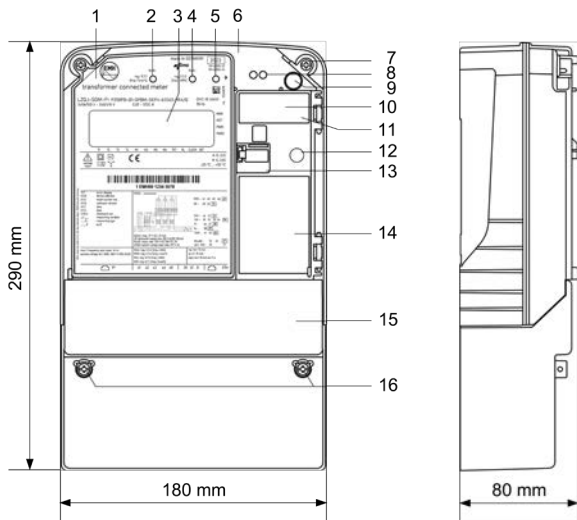

- 1 - Name plate
- 2 - Test LED for reactive power
- 3 - LC display
- 4 - Test LED for active power
- 5 - Optical call sensor (optional)
- 6 - Meter cover
- 7 - Sealing screw
- 8 - Optical data interface D0
- 9 - Call-up button
- 10 - Transformer plate (only for transformer connected meters)
- 11 - Readout battery (optional)
- 12 - Reset button
- 13 - Module compartment flap (sealable)
- 14 - Module compartment
- 15 - Terminal cover
- 16 - Sealing screws

- Optical call sensor:** For calling up the display lists on the display. The sensor is operated with a torch.
- Optical data interface D0:** For communication between meter and read-out device by means of an optical communication unit (OKK).
You will find more information on the optical data interface in the user manual.
- Readout battery:** Located under the sealable module compartment flap.
The readout battery makes it possible to read the display and read out the meter via the optical data interface D0, even if the meter is not connected to voltage. It also buffers the real time clock.
- Reset button:** Located under the sealable module compartment flap.
The reset button can be used to reset the maximum registers, for example.
You will find more information on the reset button in the user manual.
- Module compartment:** Located under the sealable module flap. A modem or interface module can be deployed here. Installation and removal can be performed under voltage.

Name plate (example)

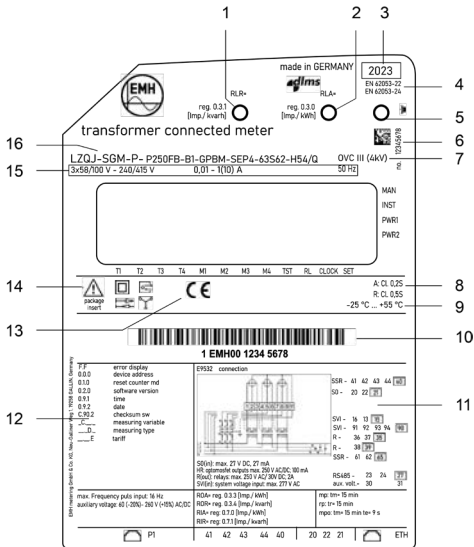

- 1 - Test LED for reactive power
- 2 - Test LED for active power
- 3 - Year of construction
- 4 - Product standard
- 5 - Optical call sensor
- 6 - Serial number
- 7 - Overvoltage category / utilisation category (direct connected meter)
- 8 - Accuracy class
- 9 - Operating temperature
- 10 - Space for ownership labelling
- 11 - Information about connection of the meter
- 12 - OBIS codes for the most important registers
- 13 - Conformity and certification marking
- 14 - Safety and application information
- 15 - Voltage, current, frequency
- 16 - Type designation and type code

The name plate contains data for identification of the meter, the registration mark, and technical specifications and explanations.

The cursor labelling below the display and the description of the OBIS code numbers on the name plate are designed as standard and not adapted to the meter version.

The name plate can contain more details than configured in the version in question.

Transformer plate

Transformer connected meters are equipped with a transformer plate. It is located under the sealable module flap.

Ser. No.
⊗/..... V/V
⊕/..... A/A
X

LC display

The LZQJ-SGM is equipped with an optionally illuminated liquid crystal (LC) display as per VDEW specifications 2.1.

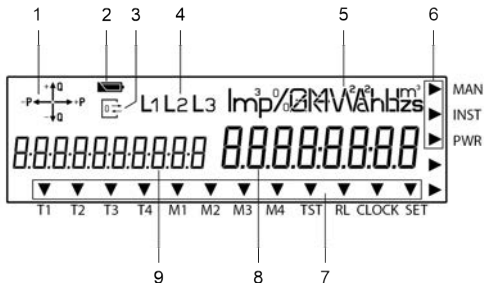

1. The **operation display** shows the energy direction that is currently being measured by the meter (export/import of active power, inductive/capacitive reactive power). If a load current is flowing, the energy direction arrow indicates which quadrant is being used for the measurement, e.g.:



1st quadrant +P/+Q



3rd quadrant -P/-Q



2nd quadrant -P/+Q



4th quadrant +P/-Q

2. The **battery status indicator** shows the residual capacity of the readout battery or the internal power reserve of the real time clock.



= Full power, the real time clock is buffered in this instance



= Power reserve run-down, the readout battery is empty (or not available) and the internal battery is empty. In this instance, the real time clock cannot be buffered.

3. The **communication display** lights up permanently when the data interface (optical or electrical) and the meter are communicating. It flashes when parametrisation mode is active.
4. The **phase display** indicates when individual phase voltages are applied. All 3 symbols flash when the rotating field is wrong.

5. The **unit** shown matches the type of energy being measured or the measurement displayed.
6. The **additional cursor field** displays the operating states for the meter. The arrows indicate whether any manipulation or an installation error was registered or if the power threshold was exceeded.
 - MAN** The cursor is active where any manipulation of the terminal cover or meter cover or any magnetic influence is registered.
 - INST** The cursor is active if an entry has been registered in the installation control register.
 - PWR** The cursor is active if one or more power thresholds defined in the meter were exceeded.
7. The **standard cursor field** displays the operating states for the meter. The arrows indicate the active tariff and maximum registers, the tariff activation source (CLOCK) and additional information.
 - T1 - T4** Tariff information for energy.
 - M1 - M4** Tariff information for power.
 - TST** The cursor is displayed if test mode is activated.
 - RL** The cursor flashes as long as a resetting lock is active.
 - CLOCK** The cursor is active when the internal device clock actuates the tariff meter.
 - SET** The corresponding cursor is active when the meter is in Set mode.
8. The **value area** displays the measurements.
9. The **code area** defines the measurements according to the OBIS key. The display can show all six value groups.

Installation and start-up

The meters in series LZQJ-SGM are suitable for wall mounting as per DIN 43857-2.

When connecting the meter, always observe the corresponding connection diagram, which is located on the meter's name plate and in the delivery documents. Please also observe the notes on the installation control register.

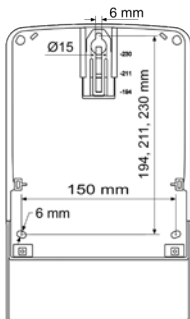

DANGER

Risk of fatal injury due to arcing and electric shock!

The voltage taps in the meter are not fuse-protected, and are connected directly to the measuring voltage potential.

External devices that are operated using the meter's voltage taps must be fuse-protected with a pre-fuse of ≤ 0.5 A in accordance with the applicable technical regulations.



DANGER

Risk of fatal injury due to arcing and electric shock!

The inputs and outputs for the additional terminals, including the external power supply inputs, are not fuse-protected in the meter.

- Fuse-protect the inputs with a pre-fuse of ≤ 0.5 A in accordance with the applicable technical regulations.
- The outputs must be fuse-protected as per the current specifications on the meter name plate in accordance with the applicable technical regulations.
- Note that the outputs are split into different potential islands as per the specification on the name plate.

DANGER

Risk of fatal injury in case of contact with live parts!

During installation or when replacing the meter, the wires connected to the meter must be de-energised.

- The installer bears responsibility for coordinating the rated values and parameters of the supply-side overcurrent protection devices with the maximum rated currents of the meter.
- Remove the corresponding pre-fuses, on the mains side and on the creation side in case of a two-sided feed. Store them in a secure location to ensure that no one else can insert the pre-fuses again without being noticed.
- Make sure that all connected devices (e.g. control and monitoring systems) are switched off.
- If you use selective automatic circuit breakers for system disconnection, secure them to prevent them from being switched on again without being noticed.
- Before the installation of a meter, make sure that the consequences of disconnecting the electrical system will not result in danger to the life or health of persons or cause any economic damage.
- To avoid any danger or damage, take appropriate measures to prevent malfunctions before disconnection of the system.
- Use only the specified screw-type terminals for installation and connection of the meter.

ATTENTION

Application of excessive torque will damage the connection terminals!

The appropriate torque is dependent on the type of connection line involved and its maximum current.

- Make sure that the screws of the connection terminals are undamaged and smooth-running before starting the screwing process.
- Tighten the connection terminals to the corresponding torque as per IEC 60999-1.

Connection to current and voltage terminals

Proceed as follows when connecting the LZQJ-SGM:

1. Ensure that all lines are free from voltage.
2. Shorten the conductors to the necessary length if necessary.
3. Strip each of the conductors to the stripping length specified in the table below (for transformer connected meters, see Seite 16; for direct connected meters, see Seite 20).
4. In case of finely stranded conductors, equip each wire with a ferrule.
5. Open the screw-type terminal.
6. Insert the conductor into the screw-type terminal up to its insulation.
7. Tighten the screw of the screw-type terminal while observing the maximum torque as specified in the above table. Ensure that the cable insulation is not put inside the terminal.
8. Repeat the process until all conductors are connected.

a) Transformer connected meter

Transformer connected meter	Current and voltage terminals	Additional terminals
Terminal dimensions W x H or d (mm)	5.3 x 5.5	2.6 x 2.2
Minimum connection cross sections (mm ²)	2.5	1.0
Maximum connection cross sections (mm ²)*	10	2.5
Minimum torques (Nm)	1.2	—
Maximum torques (Nm)	1.7	—
Screw type	Cross slot combination screw type PZ1 (as per ISO 4757)	Spring-loaded terminal
Thread size	M4	—
Stripping length (mm)	10.0	5.0

* Rated connection capacity based on IEC 60999-1

Terminal block

The specific terminal assignment can be found on the name plate of the meter.

View from the front (maximum terminal assignment, specifications in mm)

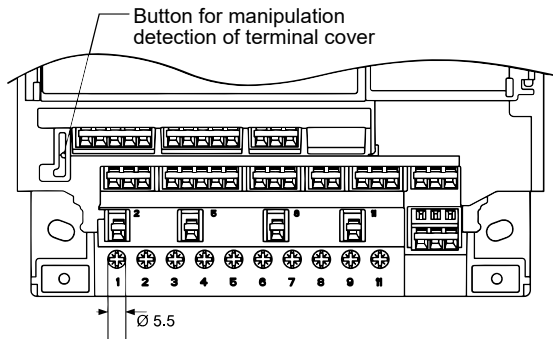

View from below (maximum terminal assignment, specifications in mm)

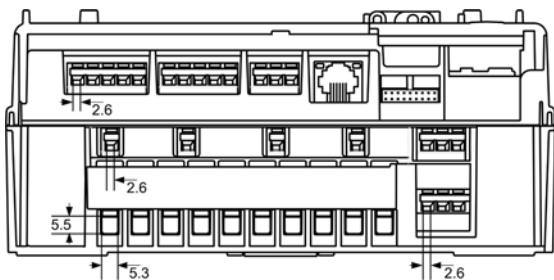

DANGER

Risk of fatal injury due to arcing and electric shock!

The voltage taps in the meter are not fuse-protected, and are connected directly to the measuring voltage potential.

The transformer connected meter must be fuse-protected in a voltage circuit using a pre-fuse with ≤ 6 A.

DANGER

Risk of fatal injury from high voltage when current transformers disconnected!

In transformer connected meters, the high voltage generated on a disconnected current transformer can cause fatal injuries, will destroy the current transformer, and can result in electric arcs on the terminal block.

Before disconnecting the current paths, short-circuit the secondary circuits of the current transformer at its testing terminals.

DANGER

Risk of fatal injury from excess voltages on the terminals of the current paths!

The voltages on the terminals of the current paths must not be higher than the rated voltages of the voltage circuits and not be higher than 300 V towards N. Excess voltages can lead to fires or electric shock.

Use the meter only with suitable current transformers to avoid exceeding the voltage limits. If necessary, the secondary side of the transformers must be earthed.

DANGER

Risk of fatal injury from high voltage when voltage transformers are used!

- Observe all the safety instructions in the documents for the voltage transformers in use.
- If necessary, the secondary side of the voltage transformers must be earthed.

Connection information

Example of a transformer connected meter:

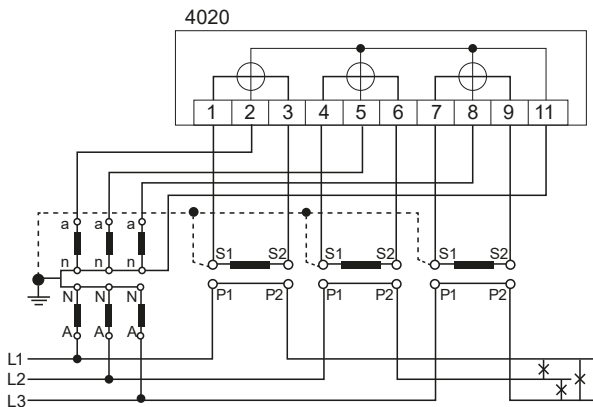

You will find further connection diagrams as per DIN 43856 in the user manual.

b) Direct connected meter

Direct connected meter	Current and voltage terminals	Additional terminals
Terminal dimensions W x H or d (mm)	9.8 x 10.9	2.6 x 2.2
Minimum connection cross sections (mm ²)	16	1.0
Maximum connection cross sections (mm ²)*	35	2.5
Minimum torques (Nm)	4.0	—
Maximum torques (Nm)	5.0	—
Screw type	Cross slot combination screw type PZ2 (as per ISO 4757)	Spring-loaded terminal
Thread size	M10	—
Stripping length (mm)	18.0	5.0

* Rated connection capacity based on IEC 60999-1

Terminal block

The specific terminal assignment can be found on the name plate of the meter.

View from the front (maximum terminal assignment, specifications in mm)

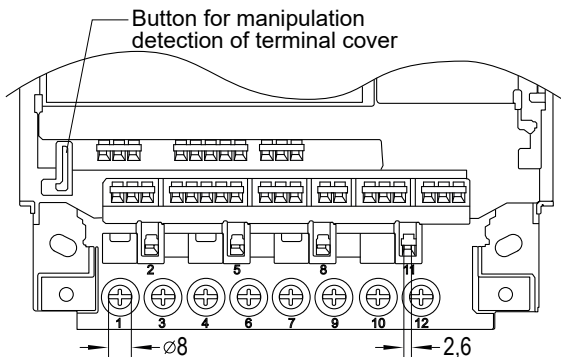

View from below (maximum terminal assignment, specifications in mm)

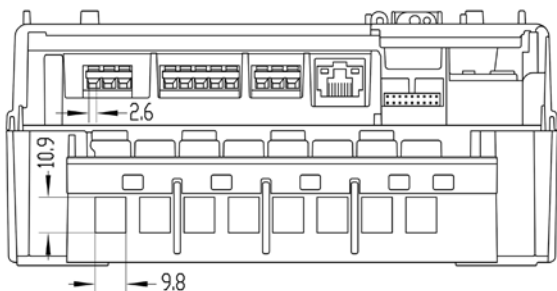

When the devices are tested, the voltage circuits are disconnected by a path separator.

Remove the path separator again when resuming normal operation!

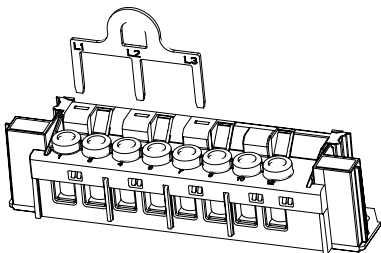

DANGER

Improper installation endangers life and health, and can lead to malfunctions and material damage!

The voltage connections in the meter are not fuse-protected, and are connected directly to the measuring voltage potential.

- The connecting paths must be fuse-protected as per the applicable technical regulations and in accordance with the current specification on the meter's name plate.
- Use an overcurrent protection device rated for a maximum of 100 A as per the applicable Technical Connection Rules for Power Installations (e.g. selective main line circuit breaker) upstream of a meter with direct connection.

Connection information

Example of a direct connected meter:

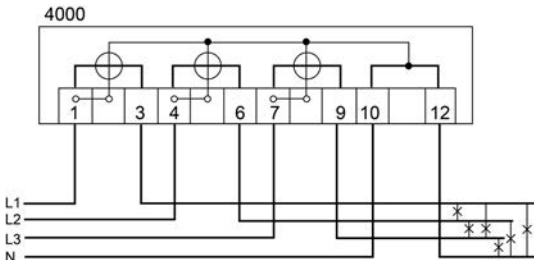

If 60A meter pins are used, the device may only be operated up to a maximum current of 60A.



You will find further connection diagrams as per DIN 43856 in the user manual.



Additional terminals (transformer connected meters and direct connected meters)

In addition to the connection diagram for current and voltage, the name plate contains information on the individual interfaces, such as the maximum voltage of the outputs, for example.

The interfaces are marked with numbers, which can be found above the matching terminals in the terminal block area. Framed terminal numbers indicate the respective earth (GND) of the interface.

If the value of the framed terminal numbers is assigned more than once, these terminals are connected internally in the device.

Interface description on the name plate (example):

P1 - 
 SSR - 41 42 43 44 40
 S0 - 20 21
 ETH - 
 SVI - 13 15
 R - 36 37 35
 RS485-23 24 27
 aux.volt.-30 31

P1: P1 HAN port
 SSR: Opto-MOSFET semiconductor relay
 S0: S0 input
 ETH: Ethernet
 SVI: System voltage input
 R: Relay output
 RS485: Data interface
 aux.volt: external auxiliary voltage supply

This description provides the basis for the following possible wiring:

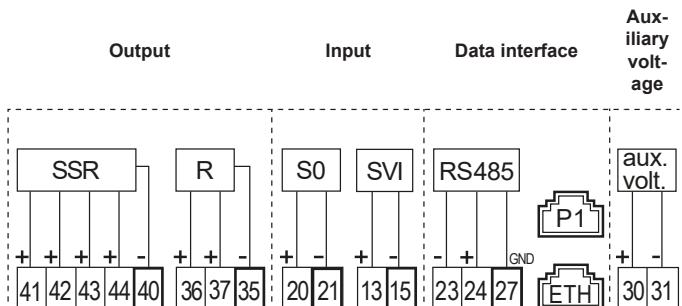

The electrical data interfaces RS232, RS485 and CL0 are implemented by means of spring-loaded terminals as standard.

The assignment is as follows:

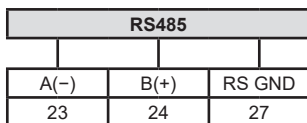
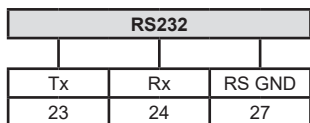

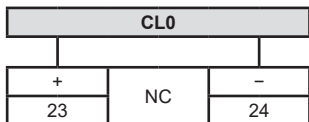

Optionally, the electrical data interfaces RS232, RS485 and CL0 can be implemented by means of RJ12 sockets.

The P1 interface is implemented by means of an RJ12 socket, and the Ethernet interface by means of an RJ45 socket.

The pin assignment for RJ12 and RJ45 can be found in the user manual.

Connection to spring-loaded terminals

Proceed as follows to connect external devices to the spring-loaded terminals:

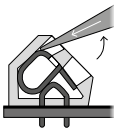
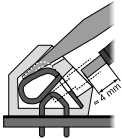
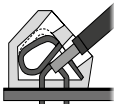
1. Shorten the conductors to the necessary length.
2. Strip 4 to 5 mm of the conductor.
3. If it is a finely stranded conductor, equip it with a ferrule. Ensure that all individual wires are fully inside the terminal.
4. Push the lever of the spring-loaded terminal down with the screwdriver until the terminal opens.
 
5. Insert the line into the open terminal up to its insulation. Ensure that the cable insulation is not put inside the terminal.
 
6. Remove the screwdriver to allow the terminal to close.
 
7. Repeat the process until all conductors are connected.

Securing the terminal cover

To prevent any unauthorised access to the connection terminals, the terminal cover is attached with 2 sealing screws (slot and PZ2 drive), which you can secure with seals.

ATTENTION

Application of excessive torque will damage the device!

Tighten the sealing screws on the terminal cover with a maximum torque of 0.5 Nm.

Readout battery (optional)

The replaceable readout battery is a lithium battery (CR-P2, 6 V).

CAUTION

Risk of explosion if replaceable battery is not replaced properly!

- The battery may only be inserted or removed by qualified personnel. Batteries can leak or self-ignite.
- Never short-circuit, damage, heat or force open batteries.
- Dispose of the battery in the original packaging or insulate the terminals of used batteries.

In delivery condition, the battery function is inactive.

To activate it, proceed as follows:

1. Open the module compartment flap.
2. Remove the battery from the meter, turn it around and insert it again.
3. Close the module compartment flap.

Functions and operation

For a detailed description on operating the LZQJ-SGM by means of a PC connected to the meter, please see the chapter on the COMBI-MASTER 2.0 in the user manual. The following sections describe only the procedure using the buttons on the device.

Calling up display lists

The display lists below can be displayed on the meter display. The display is operated by means of the call-up and reset button. As an alternative to the call-up button, it is possible to use the optical call sensor.

The display lists contain the following:

- Operation display (alternating display)
- Display test
- Call-up list (**Std-dAtA** display all register contents in the list)
- Load profile list (**P.01** display load profile values)
- Adjustment list (**SEt** edit adjustable variables)
- Information list (**InFO-dAtA** display instantaneous values)

The display lists can be configured with the help of the COMBI-MASTER 2.0 tool.

Display control

The following applies to operation by means of the call-up button or reset button:

- **Short actuation** means pushing the button briefly for $t < 2 \text{ s}$
- **Long actuation** means pushing the button a long time for $2 \text{ s} \leq t < 5 \text{ s}$
- **Longer actuation** means pushing the button a very long time for $t \geq 5 \text{ s}$

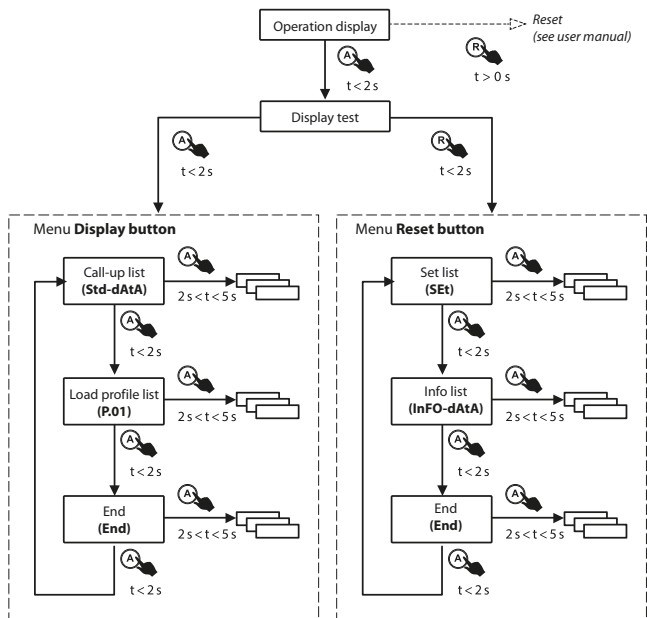



The following points apply to all menu items described below:

Two measuring or registration period lengths (generally 30 min) after the last time a button is pressed, the system automatically returns to the **operation display**. You can also achieve this through **longer actuation** of the **call-up button**. This ensures that you can observe the progress of a complete registration period at minimum on the display.



Operation display (alternating display)

The operation display is the default display. Data are displayed here in sequence with a gap of 10 s (scrolling) as default.

Operation display				
Menu item		Display	Button	
1	Operation display (scrolling)		 t < 2 s	Go to display test









Display test

In the display test, all segments of the display flash periodically. This allows you to check the reliability (performance) of individual segments. From the display test, you can go to the **call-up button menu** or the **reset button menu** through a **short actuation** of the **call-up button** or the **reset button**.

Display test				
Menu item		Display	Button	
1	Display test mode (display flashes)		 t < 2 s	Go to call-up button menu
			 t < 2 s	Go to reset button menu

Call-up button menu

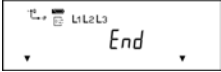
The first displayed value in the call-up button menu is the **Std-dAtA (call-up list)** menu item. Each further **short actuation** of the call-up button causes the next menu item to be displayed. To enter a menu item, use **long actuation** of the **call-up button**. The end of the menu is indicated by the **End** menu item.

Call-up button menu				
Menu item		Display	Button	
1	Entry point of the call-up list		 $t < 2 \text{ s}$	Next menu item
			 $2 \text{ s} < t < 5 \text{ s}$	Enter the call list
2	Entry point of the load profile list		 $t < 2 \text{ s}$	Next menu item
			 $2 \text{ s} < t < 5 \text{ s}$	Enter the load profile list
3	End of display menu		 $t < 2 \text{ s}$	Return to item 1



Call-up list (Std-dAtA)







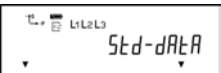

The call-up list contains all the data relevant to billing.

Every time the **call-up button** is pressed, further data are displayed.

You can skip the historical values to call up data quickly. To do so, use **long actuation** of the **call-up button**.

The end of the menu is indicated by the **End** menu item.

Call-up list				
Menu item		Display	Button	
1	Entry point of the call-up list		 $2 \text{ s} < t < 5 \text{ s}$	Enter the call list















Call-up list				
Menu item		Display	Button	
2	First register			Next menu item
			t < 2 s	
3	Next register			Next menu item
			t < 2 s	
4	Historical value			Next menu item
			t < 2 s	
5	Repeat items 3 and 4 to display further registers/historical values			
6	End of the default data list			Return to item 2
				Go to operation display
			t < 2 s	
			t > 5 s	









Load profile list (P.01, default load profile)

The first value displayed in the **load profile list** is the date of the most recently recorded load profile entry. Each further **short actuation** of the **call-up button** causes the next, historically earlier date for which a load profile entry exists to be displayed.

- You can display the time of the first (oldest) load profile entry for the selected date through **long actuation** of the **call-up button**.
- To access the next value (e.g. status of the load profile entry) in the selected registration period, perform a **short actuation** of the **call-up button** again. The last value is followed by the time of the next (later) registration period for the selected day etc.

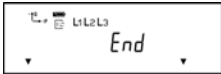
- To return to the date of the displayed load profile entries, use **long actuation** of the **call-up button**.
- The end of the menu is indicated by the **End** menu item.

Load profile list (default LP)				
Menu item		Display	Button	
1	Entry point of the load profile list		 2 s < t < 5 s	Enter the load profile list
2	Most recent date (YY.MM.DD)		 t < 2 s	Next menu item
			 2 s < t < 5 s	Enter the selected day, go to item 4
3	Date of the previous day (YYMMDD)		 t < 2 s	Next previous day, repeat if necessary
			 2 s < t < 5 s	Next menu item
4	Time of first (oldest) entry for selected day		 t < 2 s	Next menu item
5	Status of first entry of selected day		 t < 2 s	Next menu item
6	First load profile value for the first entry		 t < 2 s	Next menu item

Load profile list (default LP)				
Menu item		Display	Button	
7	Second load profile value for the first entry			Next menu item
			t < 2 s	
8	Repeat items 6 and 7 to display further registers/historical values. After the last entry of the selected day , go to point 10.			
9	Time of next entry of selected day			Repeat items 5, 6 and 7 analogously
			t < 2 s	
10	End of the load profile list for the selected day			Return to item 4
				Return to entry date (item 2 or 3)
				Go to operation display
			t < 2 s	
			2 s < t < 5 s	
			t > 5 s	

Reset button menu















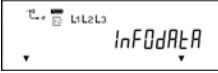

To press the **reset button**, it is necessary to break the seal of the module flap. The seal may only be broken by authorised persons!

The **reset button menu** represents an advanced function of the **reset button**. You will find information on the basic function of the reset button in the “Reset” chapter of the user manual.

The first displayed value in the **reset button menu** is the **SET (adjustment list)** menu item. Each further **short actuation** of the call-up button causes the next menu item to be displayed. To enter a menu item, use **long actuation** of the **call-up button**. The end of the menu is indicated by the **End** menu item.

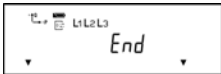
Reset button menu

Menu item	Display	Button	
1		 $t < 2 \text{ s}$	Next menu item
2		 $t < 2 \text{ s}$	Go to call-up button menu
		 $t < 2 \text{ s}$	Go to reset button menu
3		 $t < 2 \text{ s}$	Next menu item
		 $2 \text{ s} < t < 5 \text{ s}$	Enter the adjustment list
4		 $t < 2 \text{ s}$	Next menu item
		 $2 \text{ s} < t < 5 \text{ s}$	Enter the information list





Reset button menu				
Menu item		Display	Button	
5	End of display menu		 $t < 2 \text{ s}$	Return to item 3
			 $2 \text{ s} < t < 5 \text{ s}$	Return to item 3
			 $t > 5 \text{ s}$	Go to operation display











Adjustment list (SEt)

In the **adjustment list** it is possible to modify adjustable values by means of the **call-up and reset button**. Adjustable values with multiple digits are edited by means of the buttons, starting from the left (first) digit.



Adjusting the time near the end of the day (00:00:00 o'clock) or a change of season (winter time to summer time or summer time to winter time) can result in time offsets.

Adjustment list				
Menu item		Display	Button	
1	Entry point of the adjustment list		 $2 \text{ s} < t < 5 \text{ s}$	Enter the adjustment list
2	First adjustment value (here: time)		 $t < 2 \text{ s}$	Next menu item









Adjustment list				
Menu item	Display	Button		
3	Next adjustment value (here: date in the format YY•MM•DD)		 t < 2 s	Edit first digit
4	Edit the first digit (digit flashing)		 t < 2 s	Increase digit by 1
			 t < 2 s	Edit next digit
5	Repeat item 3 for further digits			
6	All digits flash		 t < 2 s	retain old value and return to item 3
			 t < 2 s	Save new value and return to item 3
7	End of the adjustment list		 t < 2 s	Return to item 2
			 t > 5 s	Go to operation display

Information list (InFO-dAtA)

The **information list** contains instantaneous values. This makes it possible to check that the meter has been installed correctly.

You can display additional menu items through **short actuation** of the **call-up button**.

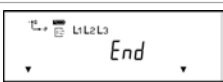
- To call up the data quickly, you can skip the historical values through **long actuation** of the **call-up button**.
- The end of the menu is indicated by the **End** menu item.

Info list				
Menu item		Display	Button	
1	Entry point of the information list		 2 s < t < 5 s	Enter the information list
2	First register (installation control register C.86.0)		 t < 2 s	Next menu item
3	Next register		 t < 2 s	Next menu item
4	Repeat item 3 to display additional registers.			
5	End of the information list		 t < 2 s	Return to item 2
			 t > 5 s	Go to operation display

Installation control register C.86.0

The installation control register C.86.0 registers installation errors. As a rule it is displayed on the alternating display or can be called up using the **information list** in the **reset button menu**.

The monitored measured values result from the instantaneous values.

If the meter was installed without errors, the register contains the value "00000000".

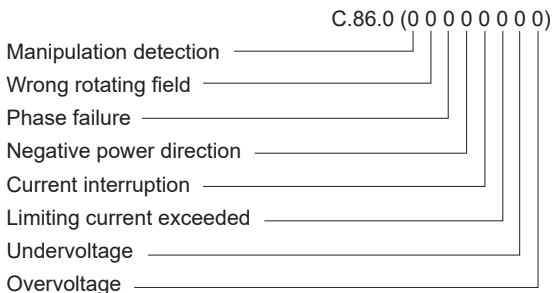

Event	Value	Meaning
Manipulation detection	1	Manipulation of the meter cover
	2	Manipulation of the terminal cover
	4	Manipulation through magnetic fields
Wrong rotating field	1	Failure of neutral conductor
	2	Wrong rotating field
Phase failure	1	Phase failure L1
	2	Phase failure L2
	4	Phase failure L3
	8	Failure of the external power supply
Negative power direction	1	Negative power direction L1 (P)
	2	Negative power direction L2 (P)
	4	Negative power direction L3 (P)
Current interruption	1	Current interruption L1
	2	Current interruption L2
	4	Current interruption L3
Limiting current exceeded ($I > I_{max}$)	1	Limiting current exceeded L1
	2	Limiting current exceeded L2
	4	Limiting current exceeded L3
Undervoltage ($U < 80\%$)	1	Voltage undershot L1
	2	Voltage undershot L2
	4	Voltage undershot L3
Overvoltage ($U > 115\%$)	1	Voltage exceeded L1
	2	Voltage exceeded L2
	4	Voltage exceeded L3

Error register F.F

The LZQJ-SGM is equipped with an error register that records the function errors of the meter. The output of the error register is performed via the display and the read-out lists.



If an error is displayed, the meter data can no longer be used as a basis for billing.

In the event of an error, please contact your supplier.



Explanation of individual error flags

The LZQJ-SGM has 5 error flags that are represented by an 8-digit hexadecimal number.

Error flag	Explanation
F.F(00000004)	Error in the data checksum due to absence of voltage
F.F(00000100)	Error in Par checksum
F.F(00000200)	Error in Set checksum
F.F(00000400)	Error in code checksum
F.F(00008000)	Error in adjustment checksum

Deleting the error register

The command for deleting the error register can only be executed if the meter is in parametrisation mode.

This is only possible when the device is open, and therefore at the manufacturer's plant.

Combi-Master 2.0 configuration and read-out program

The Combi-Master 2.0 tool is a Windows-based configuration and read-out program for EMH meters.

For a detailed description of the COMBI-MASTER 2.0, please see the relevant chapters in the user manual.

The program is used to configure the LZQJ-SGM meter, both during start-up and during adjustments while the meter is in operation. The program also makes it possible to save the meter configuration in a file.

The program itself contains plenty of information on use, which will help you work with the meter and the software.

Functional scope

Among others, the program supports the following functions:

- Reading out the configuration from a meter and saving it in a file
- Loading a configuration from a file to the meter
- Editing/modifying the configuration
- Executing functions in the meter
- Changing the application part of the firmware, locally and remotely
- Configuring and displaying the PQ measurement (power quality measurement)

Communication module

The LZQJ-SGM is equipped with an interface for a communication module.

The rated voltage of the module supply via the module interface is 17 V DC. The current limiting for the module supply is 300 mA.



For detailed information on the communication modules, please see the documentation for the VARIOMOD.

Abbreviations

Cl.	Accuracy class
D0	Optical interface as per EN 62056-21
DIN	Deutsches Institut für Normung e.V. (German Standardisation Institute)
DC	Direct connected
DSMR	Dutch Smart Meter Requirements
EN	European Norm
EVU	Utility company
HAN	Home Area Network
I	Current
IEC	International Electrotechnical Commission
IP	Ingress Protection (protection classification)
L1, L2, L3	External conductor
LC	Liquid Crystal
MP	Measuring period (of the maximum)
MPA	Output signal of the current measuring period
N	Neutral conductor
OBIS	Object Identification System
OVC	Overvoltage category
P	Active power
+P	Positive active power (customer obtains from utility company)
-P	Negative active power (customer supplies to utility company)
PQ	Power quality
Q	Reactive power
+Q	Positive reactive power
-Q	Negative reactive power
RAB	Output pulses of the reactive energy
RAW	Output pulses of the active energy
RP	Measuring period of the load profile
RTC	Real Time Clock
S0	Electrical interface as per EN 62053-31
SH	Selective main line protection
TAB	Technical Connection Rules
U	Voltage
UC	Utilisation category

EU Declaration of Conformity

EU-Konformitätserklärung EU Declaration of Conformity



Der Hersteller The manufacturer

EMH metering GmbH & Co. KG
Neu-Galliner Weg 1
19255 Gallin
GERMANY

erklärt hiermit in alleiniger Verantwortung, dass folgendes Produkt
declares under his sole responsibility that the following product

Produktbezeichnung: Elektrizitätszähler
Product designation: Electricity meter
Typenbezeichnung: LZQJ-SGM-...
Type designation:

Übereinstimmt mit den grundlegenden Anforderungen folgender EU-Richtlinien:
conforms to the essential requirements of the following EU directives:

2014/32/EU	Messgeräte (MID)	EU Amtsblatt L 96
2014/32/EU	Measuring instruments (MID)	Official Journal of the EU L96
2014/30/EU	Elektromagnetische Verträglichkeit (EMV)	EU Amtsblatt L 96
2014/30/EU	Electromagnetic compatibility (EMC)	Official Journal of the EU L96
2011/65/EU	Beschränkung der Verwendung bestimmter gefährlicher Stoffe (RoHS)	EU Amtsblatt L 174
2011/65/EU	Restriction of the use of certain hazardous substances (RoHS)	Official Journal of the EU L174

Im Rahmen der MID wurde die Konformität des Baumusters (Modul B) festgestellt und
Within the MID the conformity of the type (annex B) was attested and
die Konformitätsbewertung wurde nach Modul D durch den Hersteller vorgenommen:
the conformity assessment was performed by manufacturer according to annex D:

	Modul B (annex B)	Modul D (annex D)
Benannte Stelle (Name/Nummer): Notified body (name/number):	NM/0122	PTB/0102
Zertifikats-Nummer: Certificate number:	T12144	DE-M-AQ-PTB026

Es wurden die folgenden harmonisierten Normen und weitere technische Spezifikationen angewendet:
The following harmonized standards and other technical specifications were applied:

MID:	EMV (EMC):	RoHS:
EN IEC 62052-11:2021+A11:2022	EN IEC 62053-21:2021+A11:2021	EN IEC 63000:2018
EN 50470-3:2022	EN IEC 62053-22:2021+A11:2021	
	EN IEC 62053-23:2021+A11:2021	
	EN 55032:2015+A11:2020	

Ort, Datum: Gallin, 02 JAN 2025
Place, Date:

A blue ink signature of Dipl.-Ing. Oliver Lötter, written over a horizontal line.

Dipl.-Ing. Oliver Lötter
CTO (Chief Technology Officer)



You will find the current EU Declaration of Conformity on the internet site www.emh-metering.com in the "Products & Solutions" area in the product description for the meter.

As Declarations of Conformity can differ in terms of the applicable standards, we advise you to save the Declaration of Conformity available at the time of delivery.

TOWNSHIP

TECHNOLOGY GROUP

EMH EN 650-9401
EMH EN 650-14001
EMH EN 650-14002

EMH metering GmbH & Co. KG • Neu-Galliner Weg 1 • 19258 Gallin • GERMANY • Tel. +49 38851 326-0 • info@emh-metering.com • www.emh-metering.com